

OTC Mouldings 2			OTC Mouldings 2			OTC Mouldings 2		
Layout ID	Layout Name	Scale	Layout ID	Layout Name	Scale	Layout ID	Layout Name	Scale
1	Index	1:1	25	M28A- 30x18 D4S	1:1	49	M56- 135x18 Splay Skirting (STA)	1:1
2	M02A-23mm Quad	1:1	26	M32- 90x10 Single Bevel Arch	1:1	50	M57- 180x18 Splay Skirting (STA)	1:1
3	M03-18mm Bungalow	1:1	27	M32A- 90x18 Single Bevel Arch	1:1	51	CM60- 18mm Bolection Mould	1:1
4	M04 - 28mm Bungalow	1:1	28	M32B- 135x10 Single Bevel Arch	1:1	52	CM61- 30mm Bolection Mould	1:1
5	M09- 23x23 External Angle Comer	1:1	29	M32D - 135x18 Single Bevel Arch	1:1	53	M90- 66x11 Lambs Tongue Arch	1:1
6	M10- 9.5 Gib Corner	1:1	30	M33- 90x10 Bullnose Arch	1:1	54	M102- 60x18 Colonial Arch	1:1
7	M11- 18mm D Mould	1:1	31	M33A- 90x18 Bullnose Arch	1:1	55	M103- 85x18 Colonial Arch	1:1
8	M12- 30mm D Mould	1:1	32	M33B- 90x10 Marion Mould	1:1	56	M104- 135x18 Colonial Skirting	1:1
9	M14- 28mm Coving	1:1	33	M33C- 138x18 Bullnose Arch	1:1	57	M105- 180x18 Colonial Skirting	1:1
10	M16- 44mm Coving	1:1	34	M34- 60x18 Goverment Arch	1:1	58	M108- 67x18 Replica Arch	1:1
11	M18- 40 x10 Double Bevel Arch	1:1	35	M35- 90x18 Goverment Arch	1:1	59	M109- 85x18 Replica Arch	1:1
12	M18A- 40x10 Rebated Window Mould	1:1	36	M35A-135 x 18 Goverment Arch	1:1	60	M110- 135x18 Replica Arch	1:1
13	M18B- 40 x 18 Double Bevel Arch	1:1	37	M35B-180x18 Goverment Arch	1:1	61	M111- 180x18 Replica Arch	1:1
14	M19- 40x10 Single Bevel Arch	1:1	38	M36- 11mm Angle Fillet	1:1			
15	M19A- 40x18 Single Bevel Arch	1:1	39	M37-18mm Angle Fillet	1:1			
16	M20- 60x10 Single Bevel Arch	1:1	40	M37A-23mm Angle Fillet	1:1			
17	M20B- 60x18 Double Bevel Arch	1:1	41	M48- 66x11 NZ Colonial	1:1			
18	M21- 40x10 Bullnose Arch	1:1	42	M48A- 60x11 NZ Colonial	1:1			
19	M22- 60x10 Bullnose Arch	1:1	43	M49- 42x11 NZ Colonial	1:1			
20	M22A - 60x18 Bullnose Arch	1:1	44	M49A-90x11 NZ Colonial	1:1			
21	M26- 30x10 D4S	1:1	45	M52- 60 x 18 Single Bevel Arch	1:1			
22	M26A- 20x10 D4S	1:1	46	M53- 60x18 Splay Skirting (STA)	1:1			
23	M26B- 30x10 Coverstrip	1:1	47	M54- 115x18 Splay Skirting (STA)	1:1			
24	M26C- 25x10 D4S	1:1	48	M55- 90x18 Splay Skirting (STA)	1:1			

OTC Timber
- Since 1932 -



otctimber.co.nz



otcinfo@otctimber.co.nz



07 873 8079

MOUDLINGS

OTC Timber

– Since 1932 –



otctimber.co.nz



otcinfo@otctimber.co.nz



07 873 8079

Description:

M02A-23mm Quad

Finished Size:

23 x 23

Grade:

Finger Jointed

Length:

5.4

Finish:

LOSP H3.1 Treated & Primed

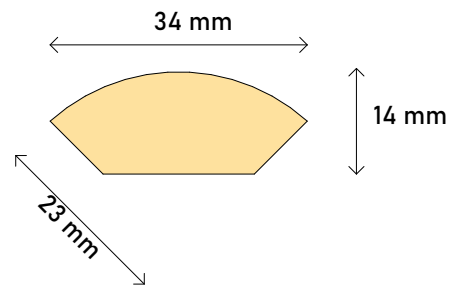

Scale: **1:1**

Date **Thursday, 14 March 2024**

Layout **2**

OTC Timber

– Since 1932 –



otctimber.co.nz



otcinfo@otctimber.co.nz



07 873 8079

Description:

M03-18mm Bungalow

Finished Size:

18 x 18

Grade:

Finger Jointed

Length:

5.4

Finish:

**Untreated
Untreated Primed
LOSP H3.1 Treated
LOSP H3.1 Treated & Primed**

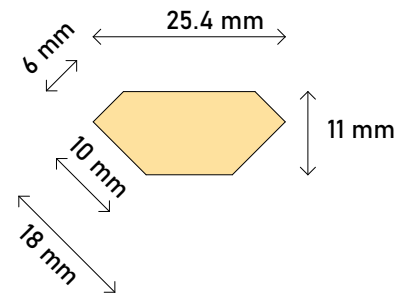

Scale: **1:1**

Date **Thursday, 14 March 2024**

Layout **3**

OTC Timber

– Since 1932 –



otctimber.co.nz



otcinfo@otctimber.co.nz



07 873 8079

Description:

**M04 - 28mm
Bungalow**

Finished Size:

28 x 28

Grade:

Finger Jointed

Length:

5.4

Finish:

**Untreated
Untreated Primed
LOSP H3.1 Treated
LOSP H3.1 Treated & Primed**

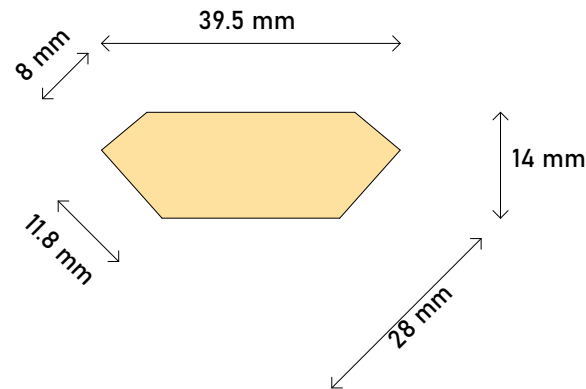

Scale: 1:1

Date: Thursday, 14 March 2024

Layout: 4



otctimber.co.nz



otcinfo@otctimber.co.nz



07 873 8079

Description:

**M09- 23x23 External
Angle Comer**

Finished Size:

16 x 16

Grade:

Finger Jointed

Length:

5.4

Finish:

**Untreated
Untreated Primed
LOSP H3.1 Treated
LOSP H3.1 Treated & Primed**

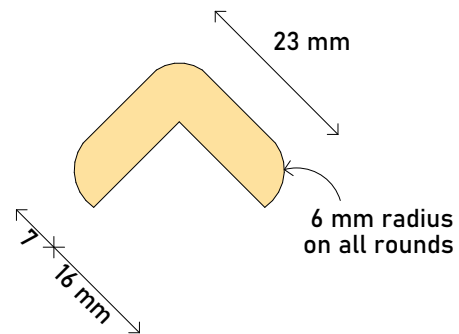

Scale: **1:1**

Date **Thursday, 14 March 2024**

Layout **5**

OTC Timber

– Since 1932 –



otctimber.co.nz



otcinfo@otctimber.co.nz



07 873 8079

Description:

M10- 9.5 Gib Corner

Finished Size:

9 x 9

Grade:

Finger Jointed

Length:

5.4

Finish:

Untreated
Untreated Primed
LOSP H3.1 Treated
LOSP H3.1 Treated & Primed

Scale: **1:1**

Date **Thursday, 14 March 2024**

Layout **6**

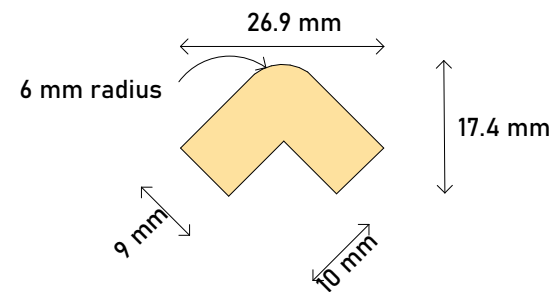

OTC Timber

– Since 1932 –



otctimber.co.nz



otcinfo@otctimber.co.nz



07 873 8079

Description:

M11- 18mm D Mould

Finished Size:

18 x 6

Grade:

Finger Jointed

Length:

5.4

Finish:

Untreated
Untreated Primed
LOSP H3.1 Treated
LOSP H3.1 Treated & Primed

Scale: **1:1**

Date **Thursday, 14 March 2024**

Layout **7**

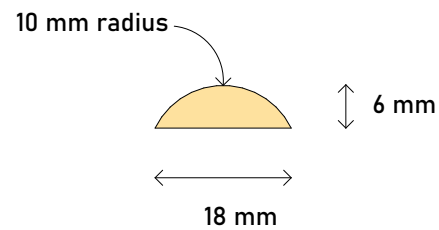

OTC Timber

– Since 1932 –



otctimber.co.nz



otcinfo@otctimber.co.nz



07 873 8079

Description:

M12- 30mm D Mould

Finished Size:

30 x 7

Grade:

Finger Jointed

Length:

5.4

Finish:

Untreated
Untreated Primed
LOSP H3.1 Treated
LOSP H3.1 Treated & Primed

Scale: 1:1

Date: Thursday, 14 March 2024

Layout: 8

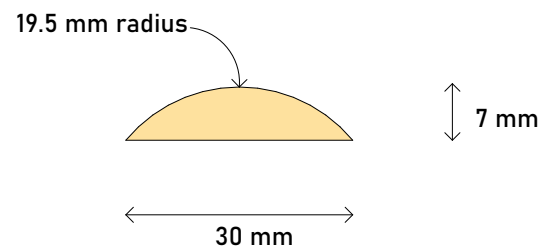

OTC Timber

– Since 1932 –



otctimber.co.nz



otcinfo@otctimber.co.nz



07 873 8079

Description:

M14- 28mm Coving

Finished Size:

28x28

Grade:

Finger Jointed

Length:

5.4

Finish:

**Untreated
LOSP H3.1 Treated**

Scale: 1:1

Date: Thursday, 14 March 2024

Layout: 9

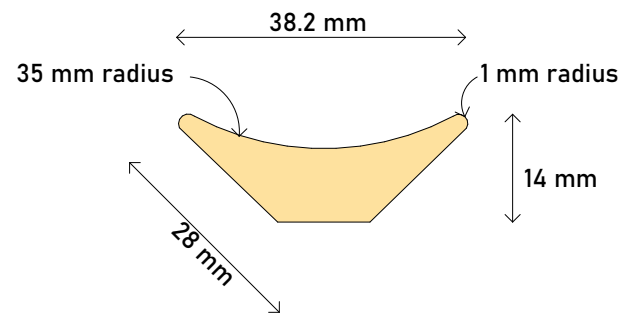

OTC Timber

– Since 1932 –



otctimber.co.nz



otcinfo@otctimber.co.nz



07 873 8079

Description:

M16- 44mm Coving

Finished Size:

44 x 44

Grade:

Finger Jointed

Length:

5.4

Finish:

**Untreated
LOSP H3.1 Treated**

Scale: 1:1

Date: Thursday, 14 March 2024

Layout: 10

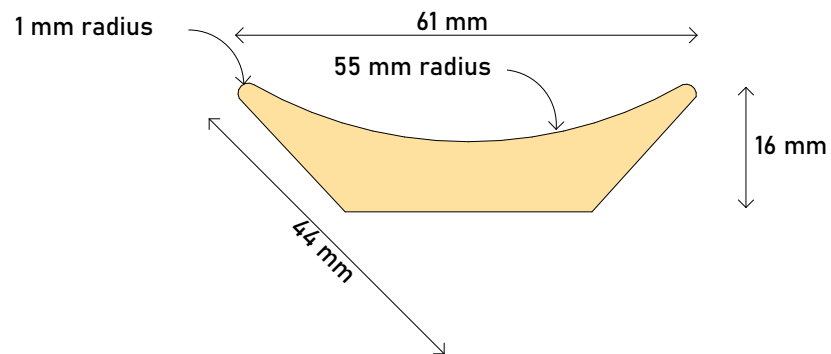

OTC Timber

– Since 1932 –



otctimber.co.nz



otcinfo@otctimber.co.nz



07 873 8079

Description:

**M18- 40 x10 Double
Bevel Arch**

Finished Size:

40 x 10

Grade:

Finger Jointed

Length:

5.4

Finish:

**Untreated
Untreated Primed
LOSP H3.1 Treated
LOSP H3.1 Treated & Primed**

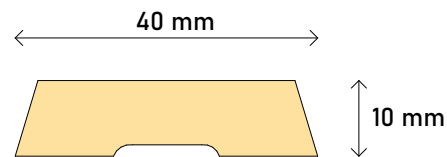

Scale: **1:1**

Date **Thursday, 14 March 2024**

Layout **11**

OTC Timber

– Since 1932 –



otctimber.co.nz



otcinfo@otctimber.co.nz



07 873 8079

Description:

M18A- 40x10 Rebated Window Mould

Finished Size:

40 x 10

Grade:

Finger Jointed

Length:

5.4

Finish:

LOSP H3.1 Treated & Primed

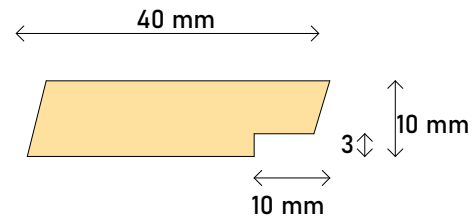

Scale: 1:1

Date: Thursday, 14 March 2024

Layout: 12

OTC Timber

– Since 1932 –



otctimber.co.nz



otcinfo@otctimber.co.nz



07 873 8079

Description:

**M18B- 40 x 18 Double
Bevel Arch**

Finished Size:

40 x 18

Grade:

Finger Jointed

Length:

5.4

Finish:

**Untreated
Untreated Primed
LOSP H3.1 Treated
LOSP H3.1 Treated & Primed**

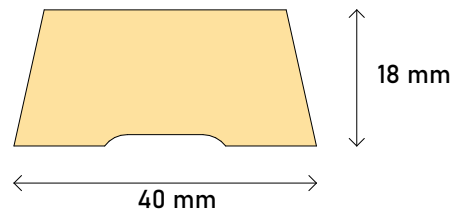

Scale: **1:1**

Date **Thursday, 14 March 2024**

Layout **13**

OTC Timber

– Since 1932 –



otctimber.co.nz



otcinfo@otctimber.co.nz



07 873 8079

Description:

**M19- 40x10 Single
Bevel Arch**

Finished Size:

40 x 10

Grade:

Finger Jointed

Length:

5.4

Finish:

**Untreated
Untreated Primed
LOSP H3.1 Treated
LOSP H3.1 Treated & Primed**

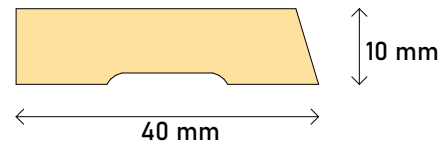

Scale: 1:1

Date: Thursday, 14 March 2024

Layout: 14

OTC Timber

– Since 1932 –



otctimber.co.nz



otcinfo@otctimber.co.nz



07 873 8079

Description:

**M19A- 40x18 Single
Bevel Arch**

Finished Size:

40 x 18

Grade:

Finger Jointed

Length:

5.4

Finish:

**Untreated
Untreated Primed
LOSP H3.1 Treated
LOSP H3.1 Treated & Primed**

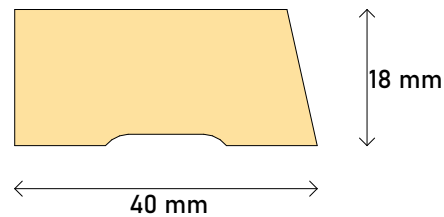

Scale: 1:1

Date: Thursday, 14 March 2024

Layout: 15

OTC Timber

– Since 1932 –



otctimber.co.nz



otcinfo@otctimber.co.nz



07 873 8079

Description:

**M20- 60x10 Single
Bevel Arch**

Finished Size:

60 x 10

Grade:

Finger Jointed

Length:

5.4

Finish:

**Untreated
Untreated Primed
LOSP H3.1 Treated
LOSP H3.1 Treated & Primed**

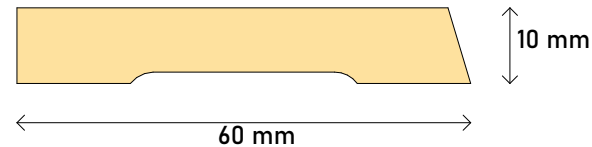

Scale: 1:1

Date: Thursday, 14 March 2024

Layout: 16

OTC Timber

– Since 1932 –



otctimber.co.nz



otcinfo@otctimber.co.nz



07 873 8079

Description:

**M20B- 60x18 Double
Bevel Arch**

Finished Size:

60 x 18

Grade:

Finger Jointed

Length:

5.4

Finish:

Untreated
Untreated Primed
LOSP H3.1 Treated
LOSP H3.1 Treated & Primed

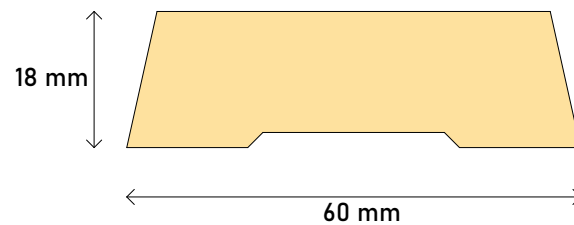

Scale: **1:1**

Date **Thursday, 14 March 2024**

Layout **17**



otctimber.co.nz



otcinfo@otctimber.co.nz



07 873 8079

Description:

M21- 40x10 Bullnose Arch

Finished Size:

40 x 10

Grade:

Finger Jointed

Length:

5.4

Finish:

**Untreated
Untreated Primed
LOSP H3.1 Treated
LOSP H3.1 Treated & Primed**

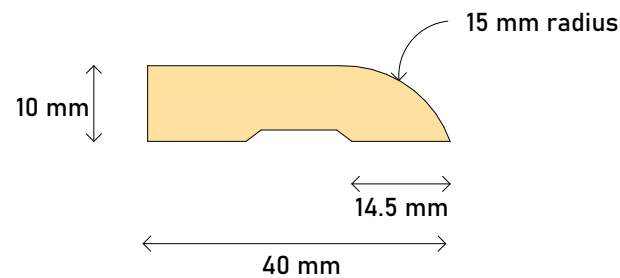

Scale: **1:1**

Date **Thursday, 14 March 2024**

Layout **18**



otctimber.co.nz



otcinfo@otctimber.co.nz



07 873 8079

Description:

M22- 60x10 Bullnose Arch

Finished Size:

60 x 10

Grade:

Finger Jointed

Length:

5.4

Finish:

**Untreated
Untreated Primed
LOSP H3.1 Treated
LOSP H3.1 Treated & Primed**

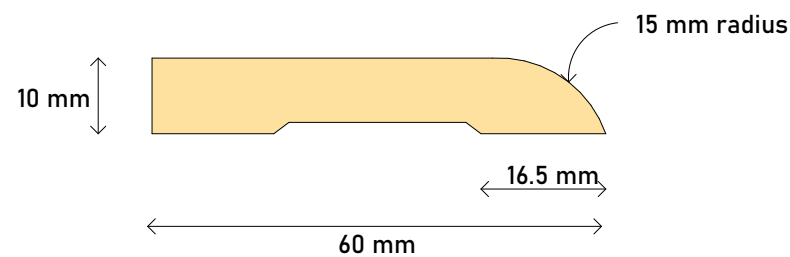

Scale: 1:1

Date: Thursday, 14 March 2024

Layout: 19



otctimber.co.nz



otcinfo@otctimber.co.nz



07 873 8079

Description:

**M22A - 60x18
Bullnose Arch**

Finished Size:

60 x 18

Grade:

Finger Jointed

Length:

5.4

Finish:

**Untreated
Untreated Primed
LOSP H3.1 Treated
LOSP H3.1 Treated & Primed**

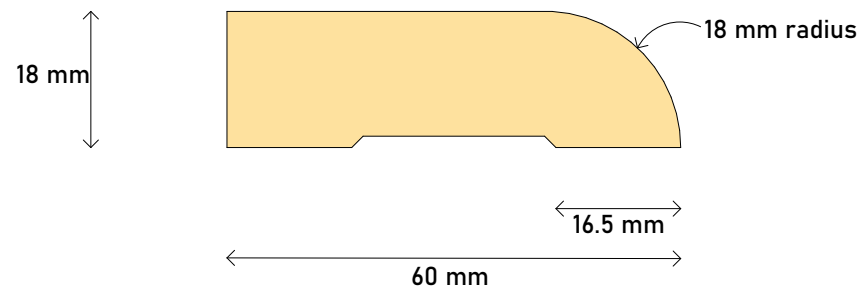

Scale: **1:1**

Date **Thursday, 14 March 2024**

Layout **20**

OTC Timber

– Since 1932 –



otctimber.co.nz



otcinfo@otctimber.co.nz



07 873 8079

Description:

M26- 30x10 D4S

Finished Size:

30 x 10

Grade:

Finger Jointed

Length:

5.4

Finish:

Untreated
Untreated Primed
LOSP H3.1 Treated
LOSP H3.1 Treated & Primed

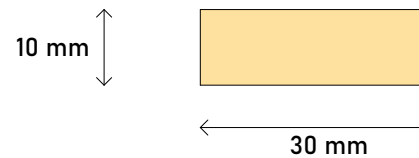

Scale: 1:1

Date: Thursday, 14 March 2024

Layout: 21

OTC Timber

– Since 1932 –



otctimber.co.nz



otcinfo@otctimber.co.nz



07 873 8079

Description:

M26A- 20x10 D4S

Finished Size:

20 x 10

Grade:

Finger Jointed

Length:

5.4

Finish:

**Untreated
Untreated Primed
LOSP H3.1 Treated
LOSP H3.1 Treated & Primed**

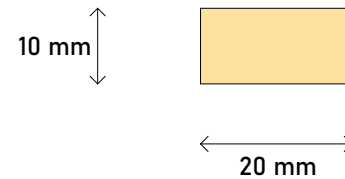

Scale: **1:1**

Date **Thursday, 14 March 2024**

Layout **22**

OTC Timber

– Since 1932 –



otctimber.co.nz



otcinfo@otctimber.co.nz



07 873 8079

Description:

**M26B- 30x10
Coverstrip**

Finished Size:

30 x 10

Grade:

Finger Jointed

Length:

5.4

Finish:

**Untreated
Untreated Primed
LOSP H3.1 Treated
LOSP H3.1 Treated & Primed**

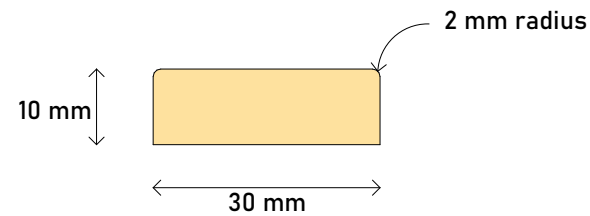

Scale: 1:1

Date: Thursday, 14 March 2024

Layout: 23

OTC Timber

– Since 1932 –



otctimber.co.nz



otcinfo@otctimber.co.nz



07 873 8079

Description:

M26C- 25x10 D4S

Finished Size:

25 x 10

Grade:

Finger Jointed

Length:

5.4

Finish:

**Untreated
Untreated Primed
LOSP H3.1 Treated
LOSP H3.1 Treated & Primed**

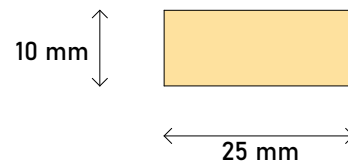

Scale: **1:1**

Date **Thursday, 14 March 2024**

Layout **24**

OTC Timber

– Since 1932 –



otctimber.co.nz



otcinfo@otctimber.co.nz



07 873 8079

Description:

M28A- 30x18 D4S

Finished Size:

30 x 18

Grade:

Finger Jointed

Length:

5.4

Finish:

**Untreated
Untreated Primed
LOSP H3.1 Treated
LOSP H3.1 Treated & Primed**

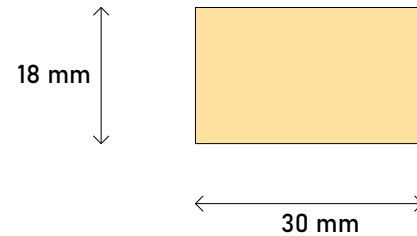

Scale: **1:1**

Date **Thursday, 14 March 2024**

Layout **25**

OTC Timber

– Since 1932 –



otctimber.co.nz



otcinfo@otctimber.co.nz



07 873 8079

Description:

**M32- 90x10 Single
Bevel Arch**

Finished Size:

90 x 10

Grade:

Finger Jointed

Length:

5.4

Finish:

**Untreated
Untreated Primed
LOSP H3.1 Treated
LOSP H3.1 Treated & Primed**

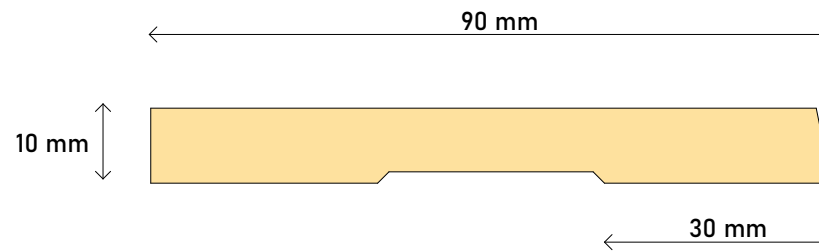

Scale: **1:1**

Date **Thursday, 14 March 2024**

Layout **26**

OTC Timber

– Since 1932 –



otctimber.co.nz



otcinfo@otctimber.co.nz



07 873 8079

Description:

**M32A- 90x18 Single
Bevel Arch**

Finished Size:

90 x 18

Grade:

Finger Jointed

Length:

5.4

Finish:

**Untreated
Untreated Primed
LOSP H3.1 Treated
LOSP H3.1 Treated & Primed**

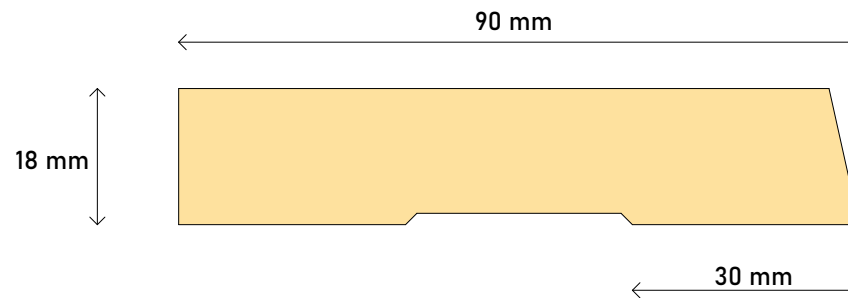

Scale: **1:1**

Date **Thursday, 14 March 2024**

Layout **27**

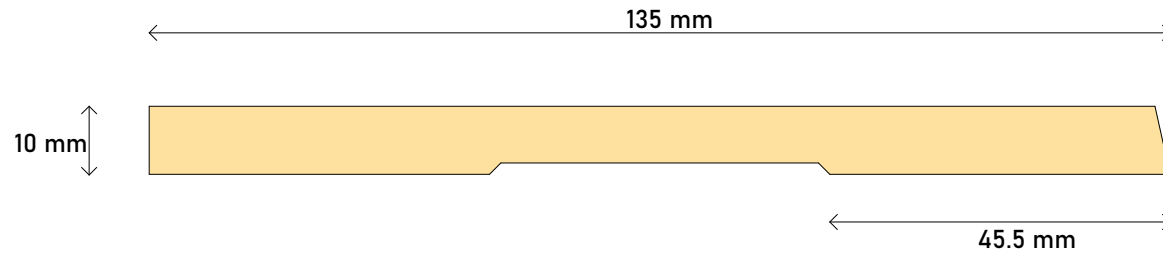

OTC Timber

– Since 1932 –



otctimber.co.nz



otcinfo@otctimber.co.nz



07 873 8079

Description:

M32B- 135x10 Single Bevel Arch

Finished Size:

135 x 10

Grade:

Finger Jointed

Length:

5.4

Finish:

Untreated
Untreated Primed
LOSP H3.1 Treated
LOSP H3.1 Treated & Primed

Scale: **1:1**

Date **Thursday, 14 March 2024**

Layout **28**

OTC Timber

– Since 1932 –



otctimber.co.nz



otcinfo@otctimber.co.nz



07 873 8079

Description:

**M32D - 135x18 Single
Bevel Arch**

Finished Size:

135 x 18

Grade:

Finger Jointed

Length:

5.4

Finish:

Untreated
Untreated Primed
LOSP H3.1 Treated
LOSP H3.1 Treated & Primed

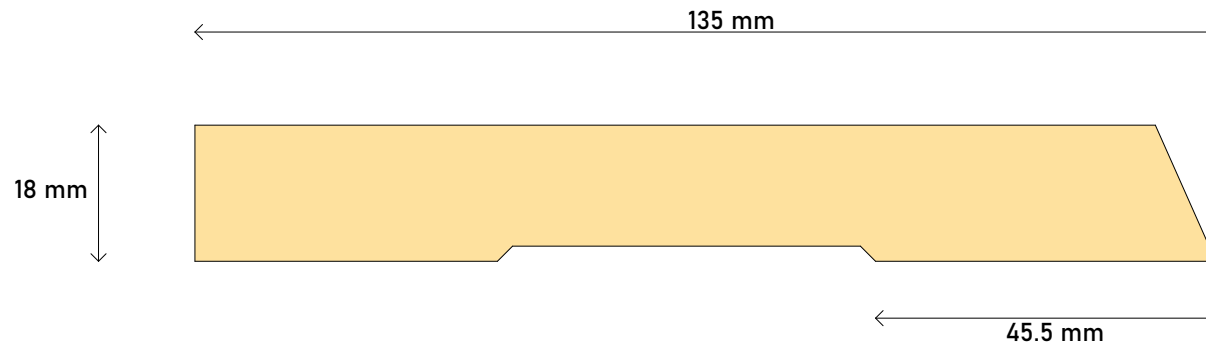

Scale: 1:1

Date: Thursday, 14 March 2024

Layout: 29

OTC Timber

– Since 1932 –



otctimber.co.nz



otcinfo@otctimber.co.nz



07 873 8079

Description:

M33- 90x10 Bullnose Arch

Finished Size:

90 x 10

Grade:

Finger Jointed

Length:

5.4

Finish:

**Untreated
Untreated Primed
LOSP H3.1 Treated
LOSP H3.1 Treated & Primed**

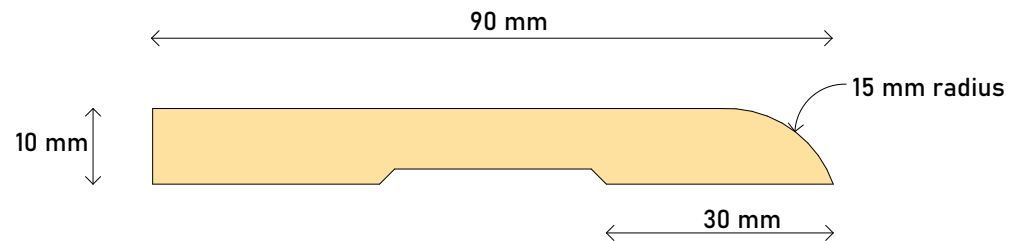

Scale: 1:1

Date: Thursday, 14 March 2024

Layout: 30



otctimber.co.nz



otcinfo@otctimber.co.nz



07 873 8079

Description:

M33A- 90x18 Bullnose Arch

Finished Size:

90 x 18

Grade:

Finger Jointed

Length:

5.4

Finish:

**Untreated
Untreated Primed
LOSP H3.1 Treated
LOSP H3.1 Treated & Primed**

Scale: **1:1**

Date **Thursday, 14 March 2024**

Layout **31**

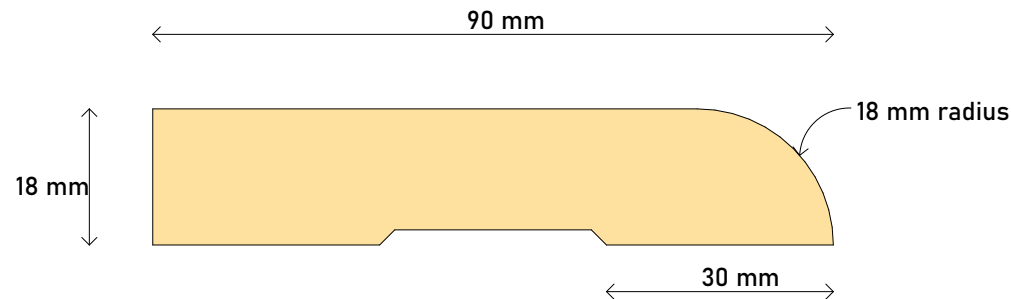

OTC Timber

– Since 1932 –



otctimber.co.nz



otcinfo@otctimber.co.nz



07 873 8079

Description:

M33B- 90x10 Marion Mould

Finished Size:

90 x 10

Grade:

Finger Jointed

Length:

5.4

Finish:

**Untreated
LOSP H3.1 Treated**

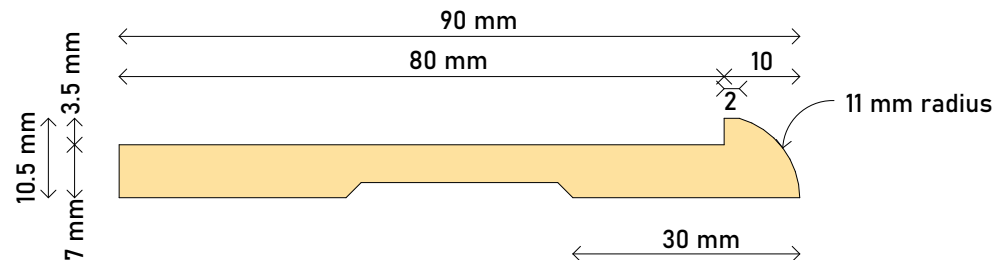

Scale: 1:1

Date: Thursday, 14 March 2024

Layout: 32

OTC Timber

– Since 1932 –



otctimber.co.nz



otcinfo@otctimber.co.nz



07 873 8079

Description:

**M33C- 138x18
Bullnose Arch**

Finished Size:

138 x 18

Grade:

Finger Jointed

Length:

5.4

Finish:

**Untreated
Untreated Primed
LOSP H3.1 Treated
LOSP H3.1 Treated & Primed**

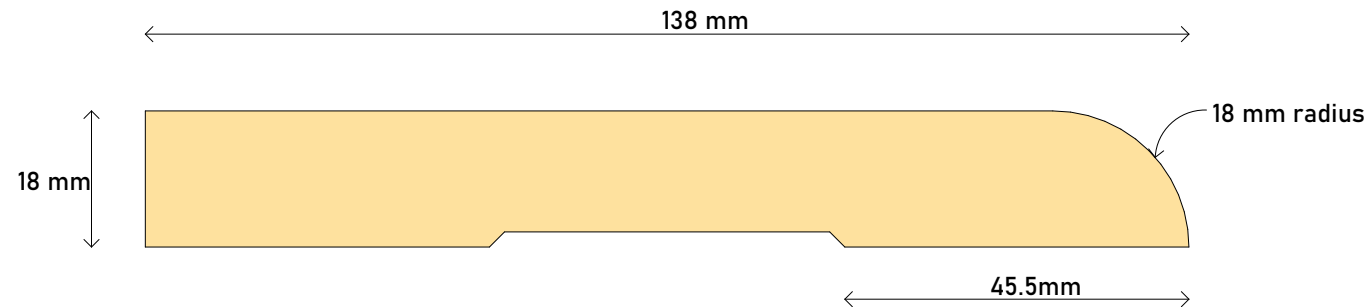

Scale: 1:1

Date: Thursday, 14 March 2024

Layout: 33



otctimber.co.nz



otcinfo@otctimber.co.nz



07 873 8079

Description:

**M34- 60x18
Government Arch**

Finished Size:

60 x 18

Grade:

Finger Jointed

Length:

5.4

Finish:

**Untreated
Untreated Primed
LOSP H3.1 Treated
LOSP H3.1 Treated & Primed**

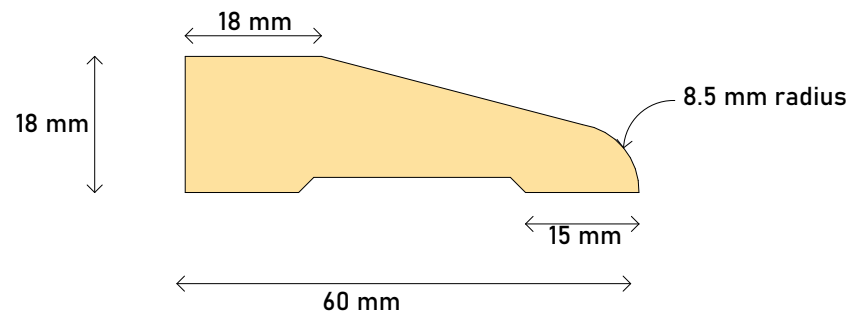

Scale: 1:1

Date: Thursday, 14 March 2024

Layout: 34

OTC Timber

– Since 1932 –



otctimber.co.nz



otcinfo@otctimber.co.nz



07 873 8079

Description:

**M35- 90x18
Government Arch**

Finished Size:

90 x 18

Grade:

Finger Jointed

Length:

5.4

Finish:

**Untreated
Untreated Primed
LOSP H3.1 Treated
LOSP H3.1 Treated & Primed**

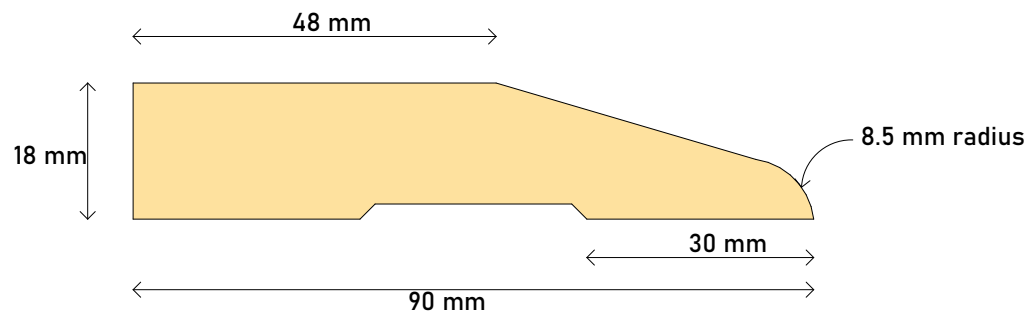

Scale: 1:1

Date: Thursday, 14 March 2024

Layout: 35

OTC Timber

– Since 1932 –



otctimber.co.nz



otcinfo@otctimber.co.nz



07 873 8079

Description:

**M35A-135 x 18
Government Arch**

Finished Size:

135 x 18

Grade:

Finger Jointed

Length:

5.4

Finish:

Untreated
Untreated Primed
LOSP H3.1 Treated
LOSP H3.1 Treated & Primed

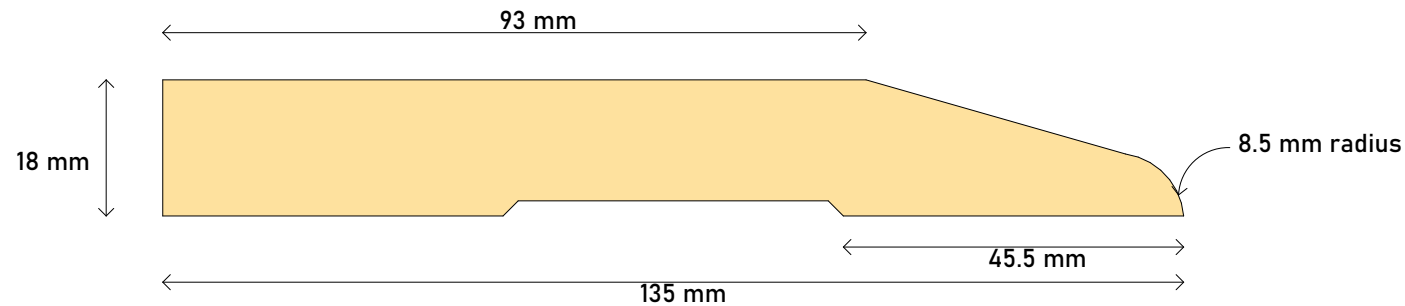

Scale: 1:1

Date: Thursday, 14 March 2024

Layout: 36

OTC Timber

– Since 1932 –



otctimber.co.nz



otcinfo@otctimber.co.nz



07 873 8079

Description:

**M35B-180x18
Government Arch**

Finished Size:

180 x 18

Grade:

Finger Jointed

Length:

5.4

Finish:

Untreated
Untreated Primed
LOSP H3.1 Treated
LOSP H3.1 Treated & Primed

Scale: 1:1

Date: Thursday, 14 March 2024

Layout: 37

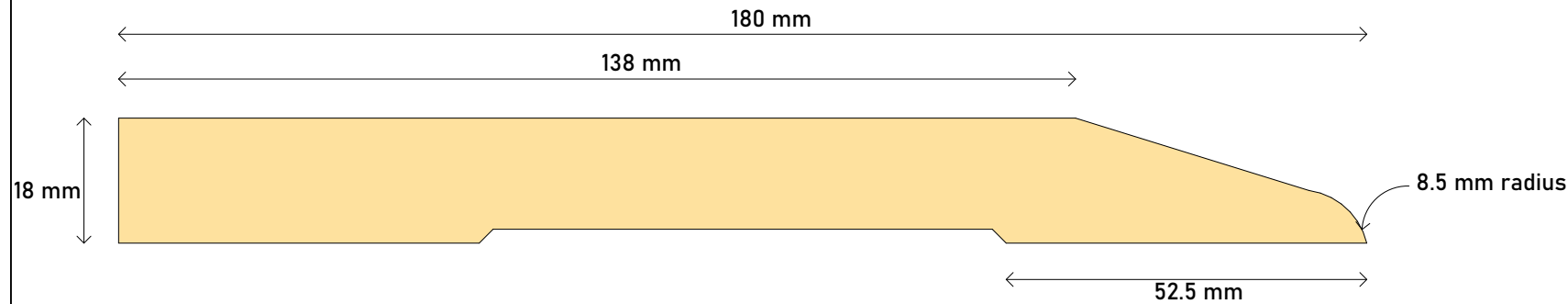



otctimber.co.nz



otcinfo@otctimber.co.nz



07 873 8079

Description:

**M36- 11mm Angle
Fillet**

Finished Size:

11 x 11

Grade:

Finger Jointed

Length:

5.4

Finish:

**Untreated
LOSP H3.1 Treated**

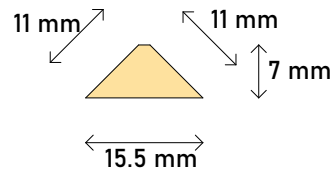

Scale: 1:1

Date: Thursday, 14 March 2024

Layout: 38

OTC Timber

– Since 1932 –



otctimber.co.nz



otcinfo@otctimber.co.nz



07 873 8079

Description:

**M37-18mm Angle
Fillet**

Finished Size:

18 x 18

Grade:

Finger Jointed

Length:

5.4

Finish:

**Untreated
LOSP H3.1 Treated**

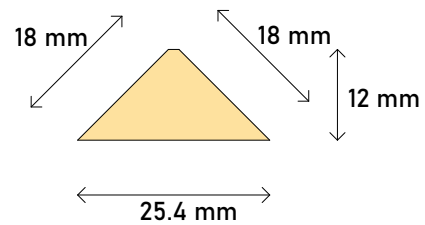

Scale: 1:1

Date: Thursday, 14 March 2024

Layout: 39

OTC Timber

– Since 1932 –



otctimber.co.nz



otcinfo@otctimber.co.nz



07 873 8079

Description:

**M37A-23mm Angle
Fillet**

Finished Size:

23 x 23

Grade:

Finger Jointed

Length:

5.4

Finish:

**Untreated
LOSP H3.1 Treated**

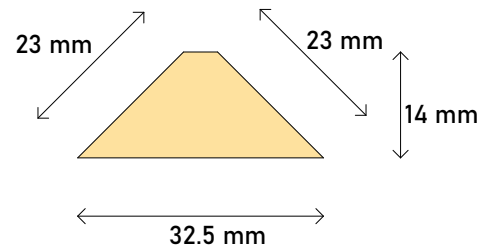

Scale: 1:1

Date: Thursday, 14 March 2024

Layout: 40

OTC Timber

– Since 1932 –



otctimber.co.nz



otcinfo@otctimber.co.nz



07 873 8079

Description:

**M48- 66x11 NZ
Colonial**

Finished Size:

66 x 11

Grade:

Finger Jointed

Length:

5.4

Finish:

**Untreated
Untreated Primed
LOSP H3.1 Treated
LOSP H3.1 Treated & Primed**

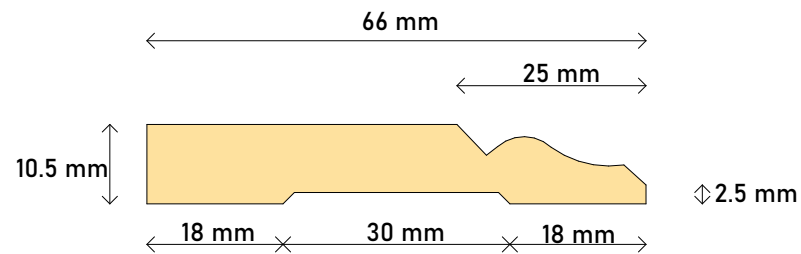

Scale: 1:1

Date: Thursday, 14 March 2024

Layout: 41

OTC Timber

– Since 1932 –



otctimber.co.nz



otcinfo@otctimber.co.nz



07 873 8079

Description:

**M48A- 60x11 NZ
Colonial**

Finished Size:

60 x 11

Grade:

Finger Jointed

Length:

5.4

Finish:

**Untreated
Untreated Primed
LOSP H3.1 Treated
LOSP H3.1 Treated & Primed**

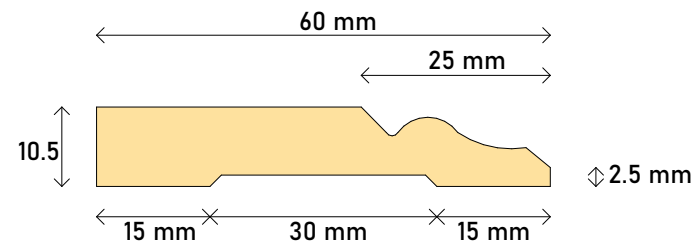

Scale: 1:1

Date: Thursday, 14 March 2024

Layout: 42

OTC Timber

– Since 1932 –



otctimber.co.nz



otcinfo@otctimber.co.nz



07 873 8079

Description:

**M49- 42x11 NZ
Colonial**

Finished Size:

42 x 11

Grade:

Finger Jointed

Length:

5.4

Finish:

**Untreated
Untreated Primed
LOSP H3.1 Treated
LOSP H3.1 Treated & Primed**

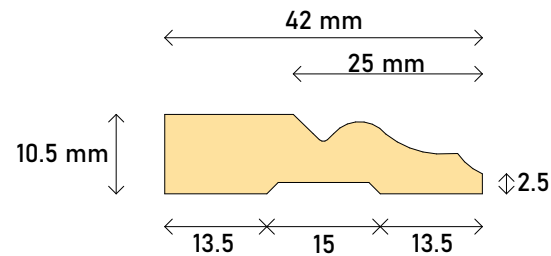

Scale: 1:1

Date: Thursday, 14 March 2024

Layout: 43

OTC Timber

– Since 1932 –



otctimber.co.nz



otcinfo@otctimber.co.nz



07 873 8079

Description:

**M49A-90x11 NZ
Colonial**

Finished Size:

90 x 11

Grade:

Finger Jointed

Length:

5.4

Finish:

**Untreated
Untreated Primed
LOSP H3.1 Treated
LOSP H3.1 Treated & Primed**

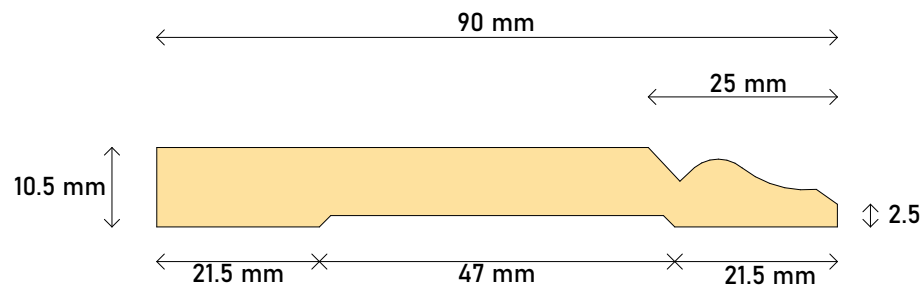

Scale: 1:1

Date: Thursday, 14 March 2024

Layout: 44

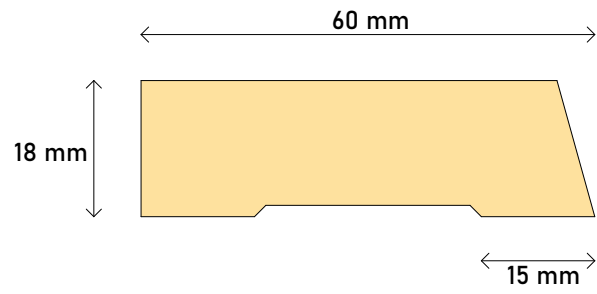

OTC Timber

– Since 1932 –



otctimber.co.nz



otcinfo@otctimber.co.nz



07 873 8079

Description:

M52- 60 x 18 Single Bevel Arch

Finished Size:

60 x 18

Grade:

Finger Jointed

Length:

5.4

Finish:

Untreated
Untreated Primed
LOSP H3.1 Treated
LOSP H3.1 Treated & Primed

Scale: **1:1**

Date **Thursday, 14 March 2024**

Layout **45**

OTC Timber

– Since 1932 –



otctimber.co.nz



otcinfo@otctimber.co.nz



07 873 8079

Description:

**M53- 60x18 Splay
Skirting (STA)**

Finished Size:

60 x 18

Grade:

Finger Jointed

Length:

5.4

Finish:

**Untreated
Untreated Primed
LOSP H3.1 Treated
LOSP H3.1 Treated & Primed**

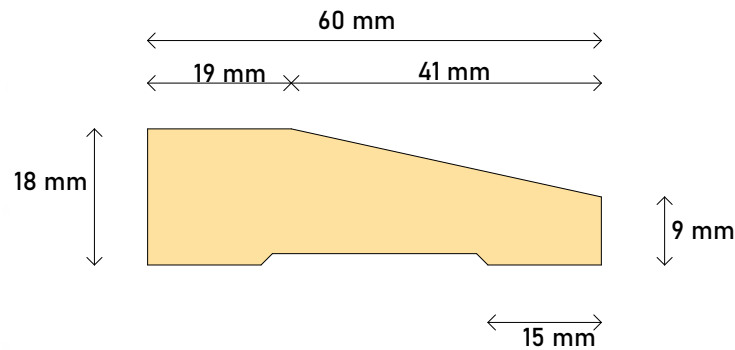

Scale: 1:1

Date: Thursday, 14 March 2024

Layout: 46

OTC Timber

– Since 1932 –



otctimber.co.nz



otcinfo@otctimber.co.nz



07 873 8079

Description:

**M54- 115x18 Splay
Skirting (STA)**

Finished Size:

115 x 18

Grade:

Finger Jointed

Length:

5.4

Finish:

**Untreated
Untreated Primed
LOSP H3.1 Treated
LOSP H3.1 Treated & Primed**

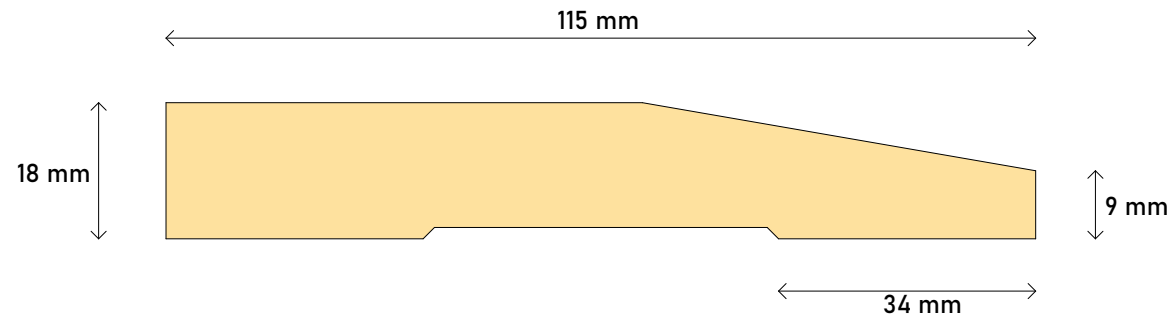

Scale: **1:1**

Date: **Thursday, 14 March 2024**

Layout: **47**

OTC Timber

– Since 1932 –



otctimber.co.nz



otcinfo@otctimber.co.nz



07 873 8079

Description:

**M55- 90x18 Splay
Skirting (STA)**

Finished Size:

90 x 18

Grade:

Finger Jointed

Length:

5.4

Finish:

**Untreated
Untreated Primed
LOSP H3.1 Treated
LOSP H3.1 Treated & Primed**

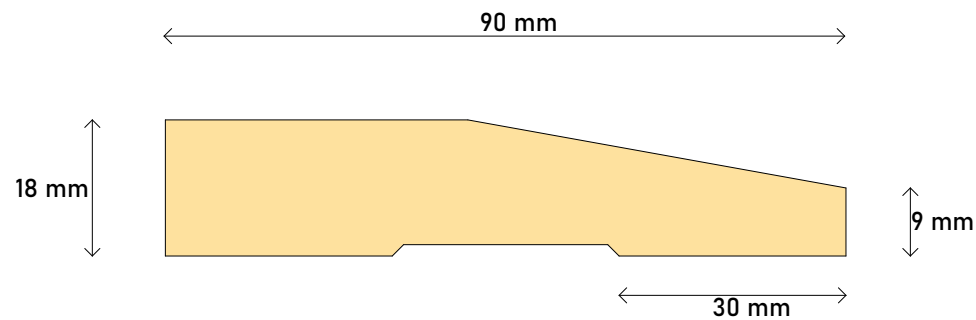

Scale: **1:1**

Date **Thursday, 14 March 2024**

Layout **48**

OTC Timber

– Since 1932 –



otctimber.co.nz



otcinfo@otctimber.co.nz



07 873 8079

Description:

**M56- 135x18 Splay
Skirting (STA)**

Finished Size:

135 x 18

Grade:

Finger Jointed

Length:

5.4

Finish:

**Untreated
Untreated Primed
LOSP H3.1 Treated
LOSP H3.1 Treated & Primed**

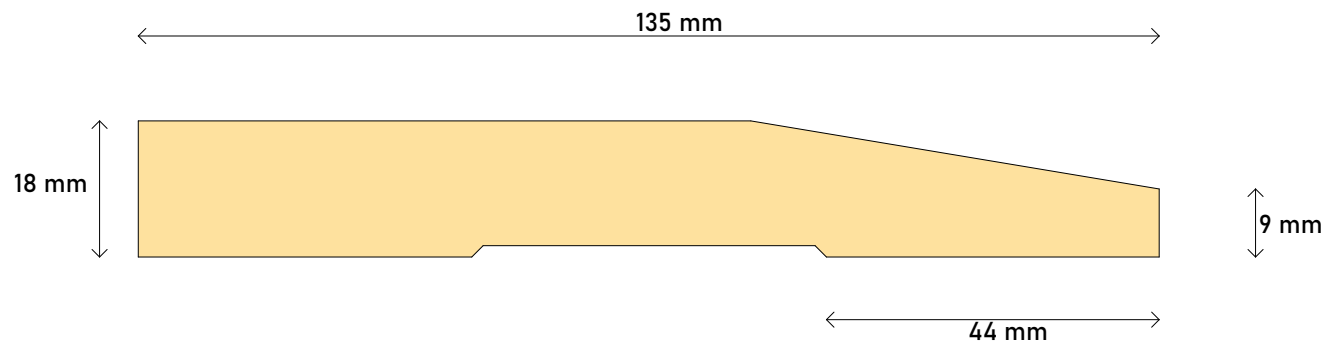

Scale: **1:1**

Date **Thursday, 14 March 2024**

Layout **49**

OTC Timber

– Since 1932 –



otctimber.co.nz



otcinfo@otctimber.co.nz



07 873 8079

Description:

**M57- 180x18 Splay
Skirting (STA)**

Finished Size:

180 x 18

Grade:

Finger Jointed

Length:

5.4

Finish:

Untreated
Untreated Primed
LOSP H3.1 Treated
LOSP H3.1 Treated & Primed

Scale: **1:1**

Date **Thursday, 14 March 2024**

Layout **50**

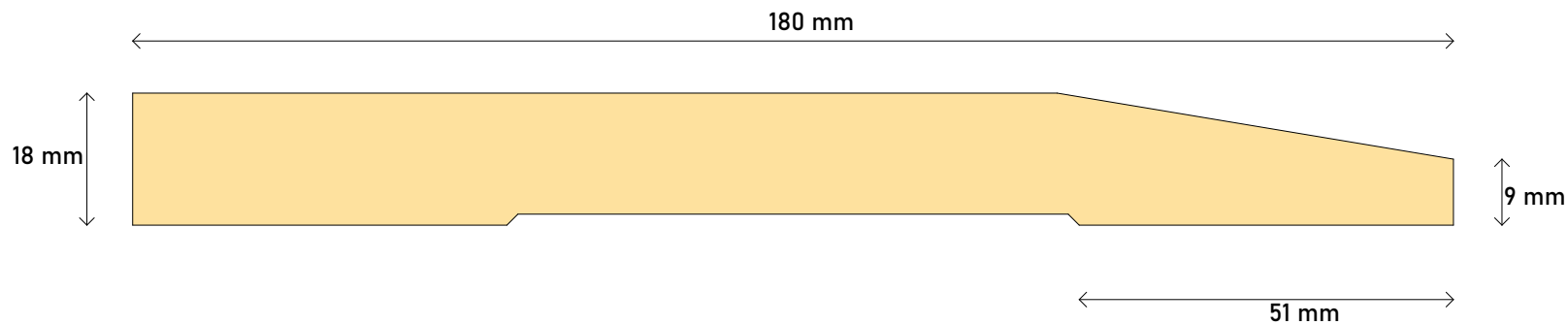

OTC Timber

– Since 1932 –



otctimber.co.nz



otcinfo@otctimber.co.nz



07 873 8079

Description:

**CM60- 18mm
Bolection Mould**

Finished Size:

19 x 10

Grade:

Clears

Length:

Random

Finish:

Untreated

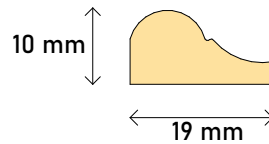

Scale: 1:1

Date Thursday, 14 March 2024

Layout 51

OTC Timber

– Since 1932 –



otctimber.co.nz



otcinfo@otctimber.co.nz



07 873 8079

Description:

**CM61- 30mm
Bolection Mould**

Finished Size:

30 x 18

Grade:

Clears

Length:

Random

Finish:

Untreated

Scale: 1:1

Date: Thursday, 14 March 2024

Layout: 52

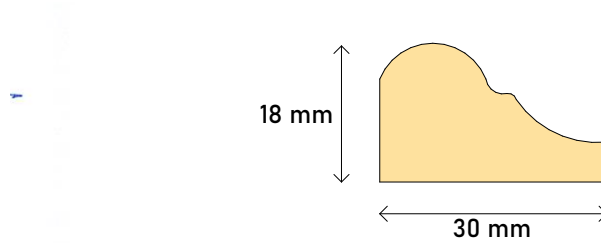

OTC Timber

– Since 1932 –



otctimber.co.nz



otcinfo@otctimber.co.nz



07 873 8079

Description:

**M90- 66x11 Lambs
Tongue Arch**

Finished Size:

66 x 11

Grade:

Finger Jointed

Length:

5.4

Finish:

**Untreated
Untreated Primed
LOSP H3.1 Treated
LOSP H3.1 Treated & Primed**

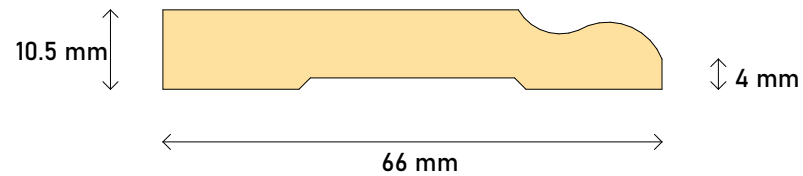

Scale: **1:1**

Date **Thursday, 14 March 2024**

Layout **53**

OTC Timber

– Since 1932 –



otctimber.co.nz



otcinfo@otctimber.co.nz



07 873 8079

Description:

M102- 60x18 Colonial Arch

Finished Size:

60 x 18

Grade:

Finger Jointed

Length:

5.4

Finish:

Untreated Primed

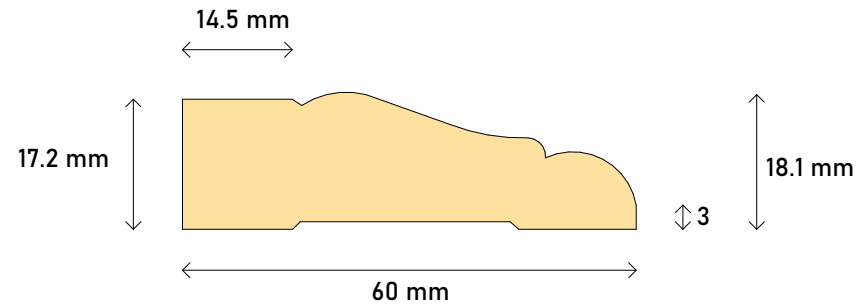

Scale: 1:1

Date: Thursday, 14 March 2024

Layout: 54

OTC Timber

– Since 1932 –



otctimber.co.nz



otcinfo@otctimber.co.nz



07 873 8079

Description:

M103- 85x18 Colonial Arch

Finished Size:

85 X 18

Grade:

Finger Jointed

Length:

5.4

Finish:

Untreated Primed

Scale: 1:1

Date: Thursday, 14 March 2024

Layout: 55

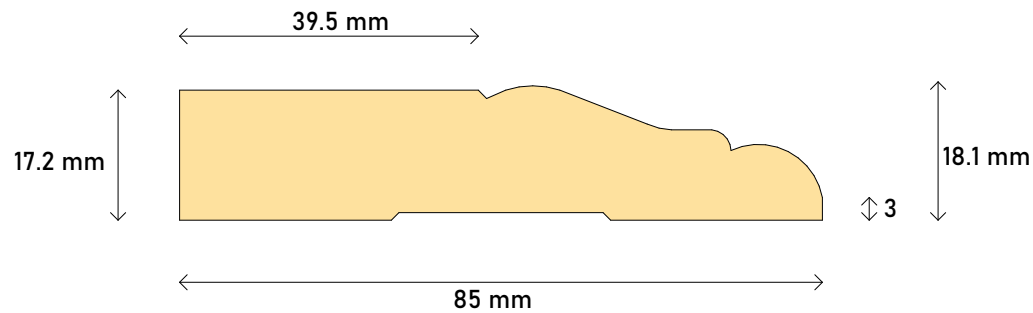

OTC Timber

– Since 1932 –



otctimber.co.nz



otcinfo@otctimber.co.nz



07 873 8079

Description:

M104- 135x18 Colonial Skirting

Finished Size:

135 X 18

Grade:

Finger Jointed

Length:

5.4

Finish:

Untreated Primed

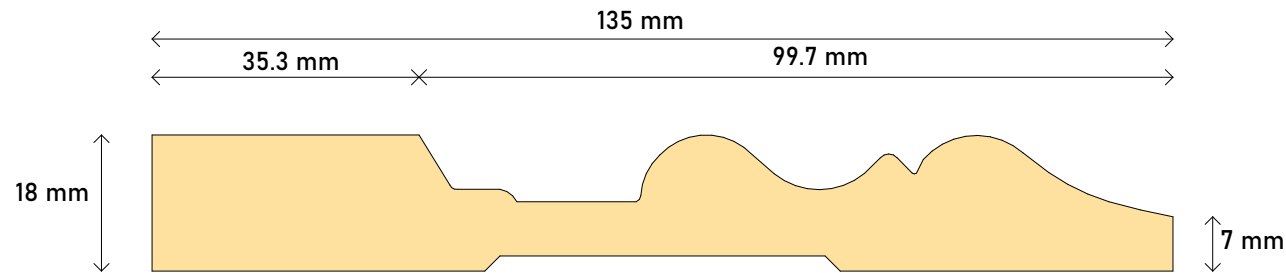

Scale: 1:1

Date: Thursday, 14 March 2024

Layout: 56

OTC Timber

– Since 1932 –



otctimber.co.nz



otcinfo@otctimber.co.nz



07 873 8079

Description:

M105- 180x18 Colonial Skirting

Finished Size:

180 x 18

Grade:

Finger Jointed

Length:

5.4

Finish:

Untreated Primed

Scale: 1:1

Date: Thursday, 14 March 2024

Layout: 57

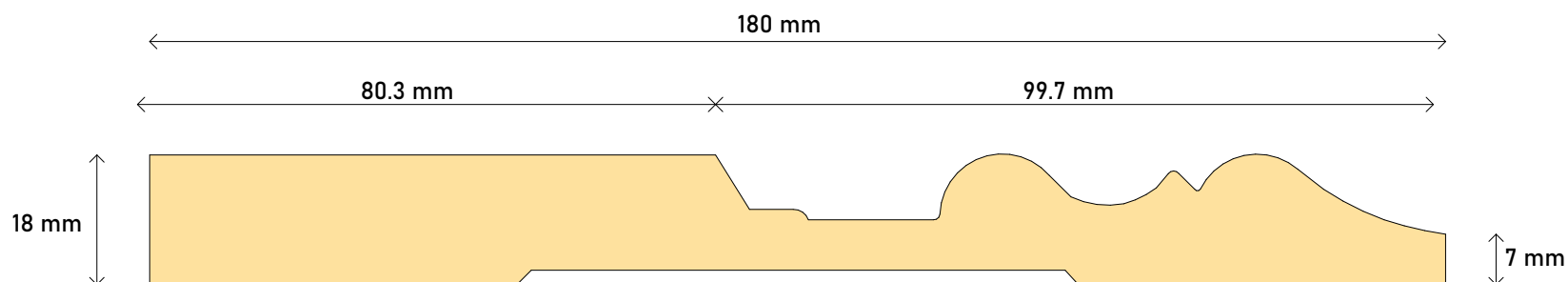

OTC Timber

– Since 1932 –



otctimber.co.nz



otcinfo@otctimber.co.nz



07 873 8079

Description:

M108- 67x18 Replica Arch

Finished Size:

67 x 18

Grade:

Finger Jointed

Length:

5.4

Finish:

Untreated Primed

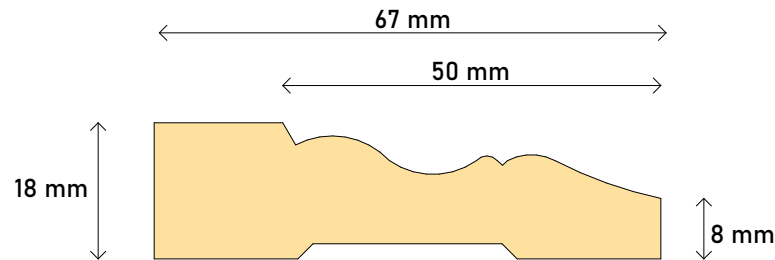

Scale: 1:1

Date: Thursday, 14 March 2024

Layout: 58

OTC Timber

– Since 1932 –



otctimber.co.nz



otcinfo@otctimber.co.nz



07 873 8079

Description:

M109- 85x18 Replica Arch

Finished Size:

85 x 18

Grade:

Finger Jointed

Length:

5.4

Finish:

Untreated Primed

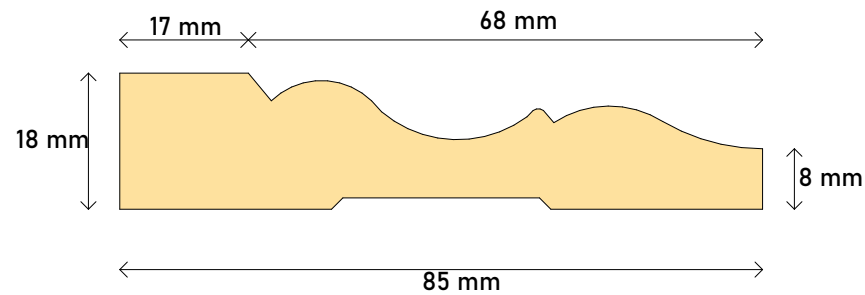

Scale: 1:1

Date: Thursday, 14 March 2024

Layout: 59

OTC Timber

– Since 1932 –



otctimber.co.nz



otcinfo@otctimber.co.nz



07 873 8079

Description:

M110- 135x18 Replica Arch

Finished Size:

135 x 18

Grade:

Finger Jointed

Length:

5.4

Finish:

Untreated Primed

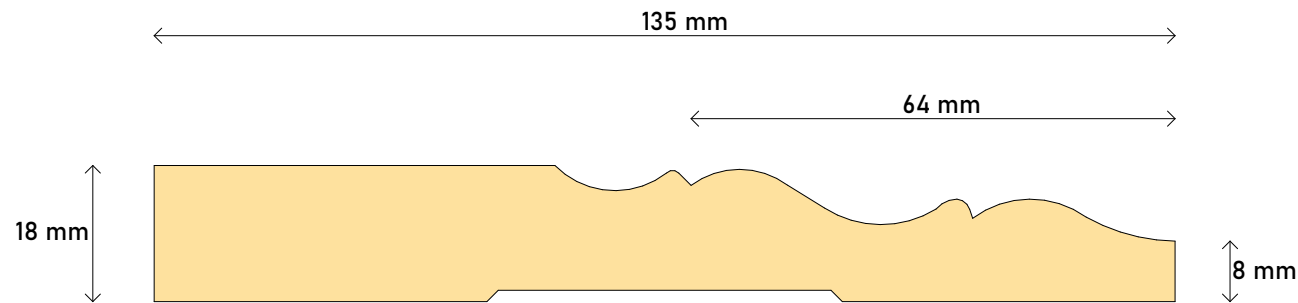

Scale: 1:1

Date: Thursday, 14 March 2024

Layout: 60

OTC Timber

– Since 1932 –



otctimber.co.nz



otcinfo@otctimber.co.nz



07 873 8079

Description:

M111- 180x18 Replica Arch

Finished Size:

180 x 18

Grade:

Finger Jointed

Length:

5.4

Finish:

Untreated Primed

Scale: 1:1

Date: Thursday, 14 March 2024

Layout: 61

